

轨道系统 规格书

MT20G

— MagTrack 20 系列



◎ 基础参数

- 工艺材质: AL6063-T5, 表面喷涂
- 外观颜色: 黑色(RAL9005)/白色(RAL9003)
- 产品长度: 110mm,220mm,440mm 可选
- 防水等级: IP20
- 成品色温: 2700K,3000K,4000K 可选
- 显指: 90
- 色容差: <3 Step (ANSI)
- 发光角度: 30°,55°
- 产品光效: 73 LM/W,68 LM/W
- 输入电压: DC24-48V,DC48V
- 发光方向: 下发光
- 调光方式: 非调光,DALI调光,涂鸦蓝牙,CASAMBI
- 产品应用: 室内
- 产品认证: CE,UKCA,ROHS,Reach
- 质保年限: 5年

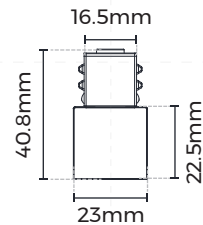
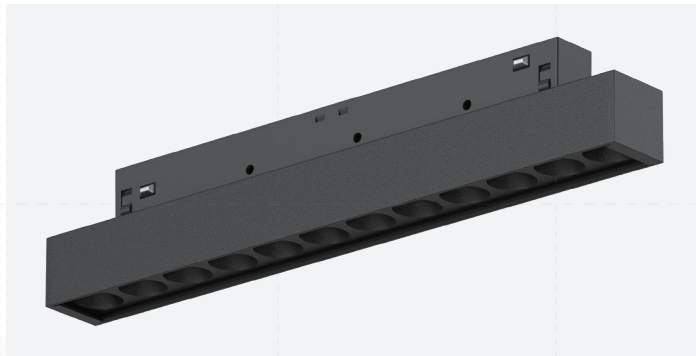

◎ 产品机械参数

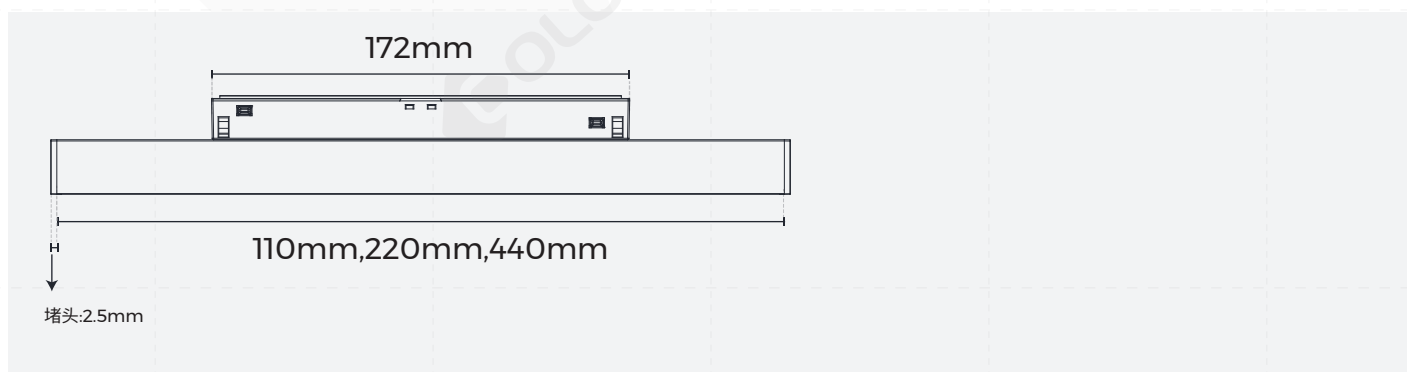

◎灯具参数

版本	商城型号	长度	输入电压 (V)	额定电流 (A)	典型功率 (W)	最大功率 (W)	显指	光束角	成品色温	流明 (LM)
常规版	MT20G	110mm	24-48VDC	0.25-0.125	6.0	6.6	>90	30°	2700K	400
									3000K	410
									4000K	440
常规版	MT20G	110mm	24-48VDC	0.25-0.125	6.0	6.6	>90	55°	2700K	370
									3000K	380
									4000K	410
常规版	MT20G	220mm	24-48VDC	0.5-0.25	12.0	13.2	>90	30°	2700K	800
									3000K	820
									4000K	880
常规版	MT20G	220mm	24-48VDC	0.5-0.25	12.0	13.2	>90	55°	2700K	740
									3000K	760
									4000K	820
常规版	MT20G	440mm	48VDC	0.50	24.0	26.4	>90	30°	2700K	1600
									3000K	1630
									4000K	1750
常规版	MT20G	440mm	48VDC	0.50	24.0	26.4	>90	55°	2700K	1480
									3000K	1520
									4000K	1630

备注:

1. 以上参数基于Ra90,4000K色温标准灯具进行测试的结果
2. 光通量允许有±10%的容差范围;
3. 以上参数均为经典值

◎光学参数

· 额定功率:6W

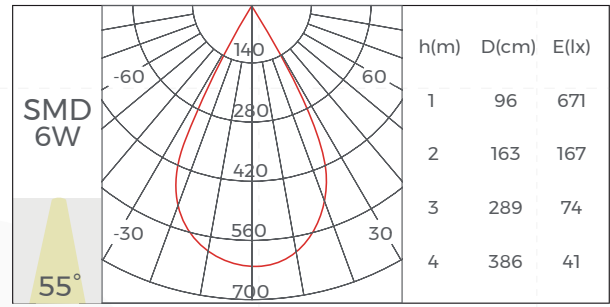
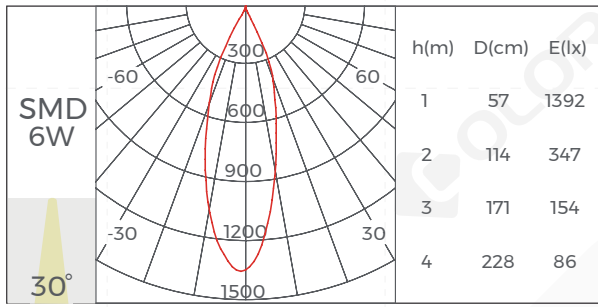

· 额定功率:12W

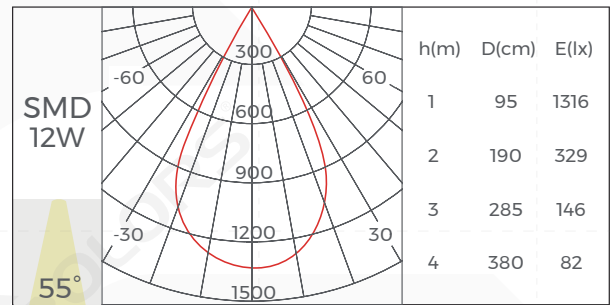
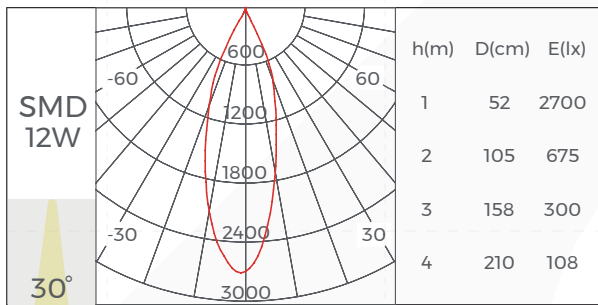

· 额定功率:24W

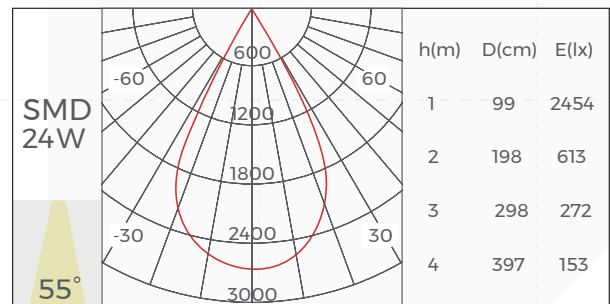
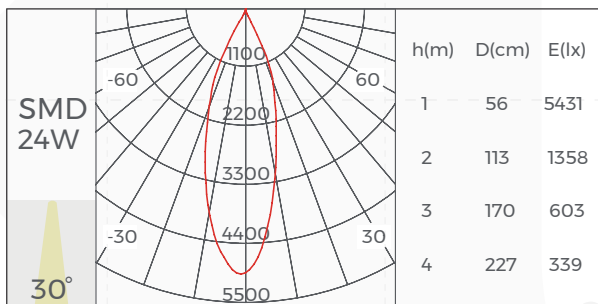

◎ MagTrack 20 产品应用

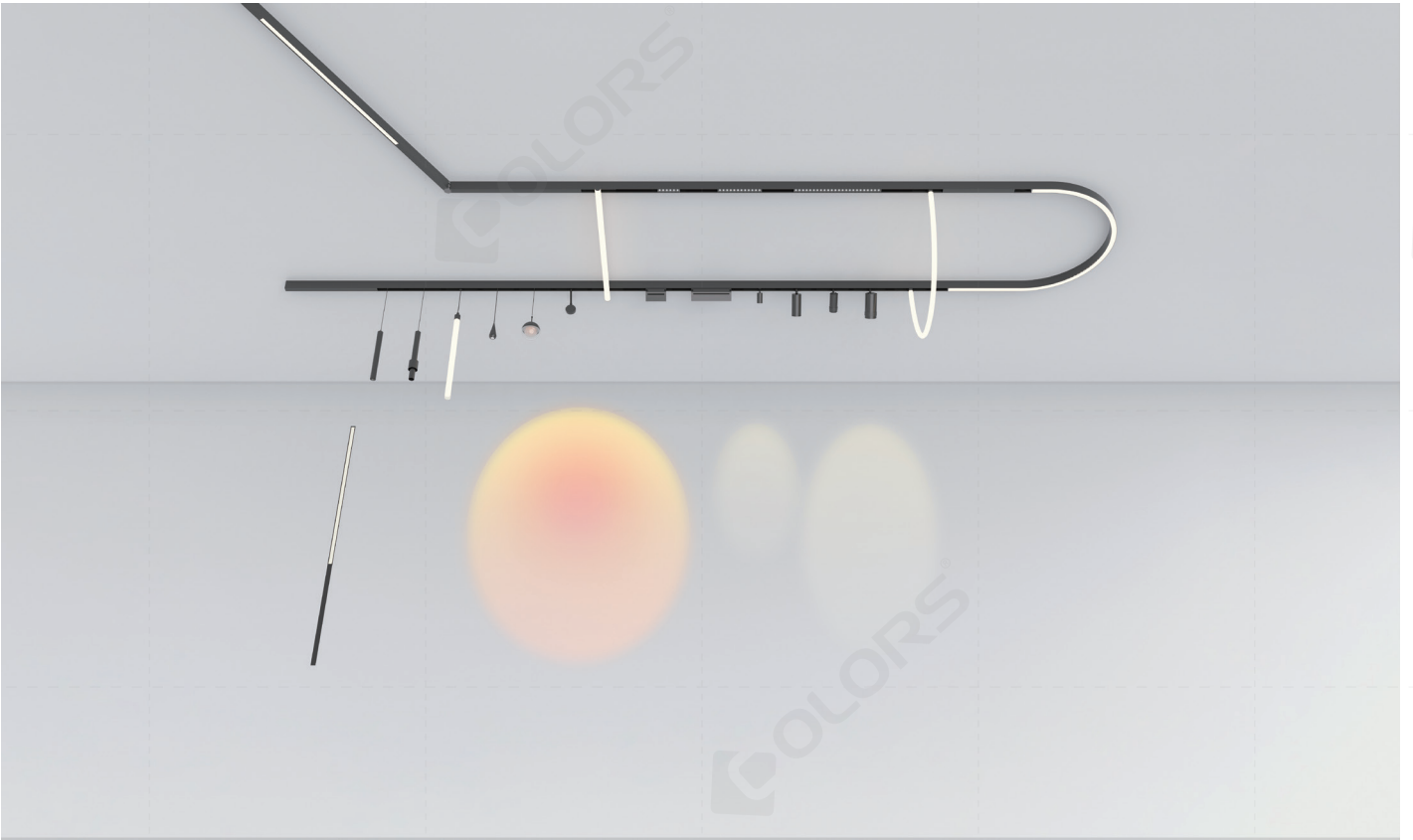

◎ 电源使用注意事项

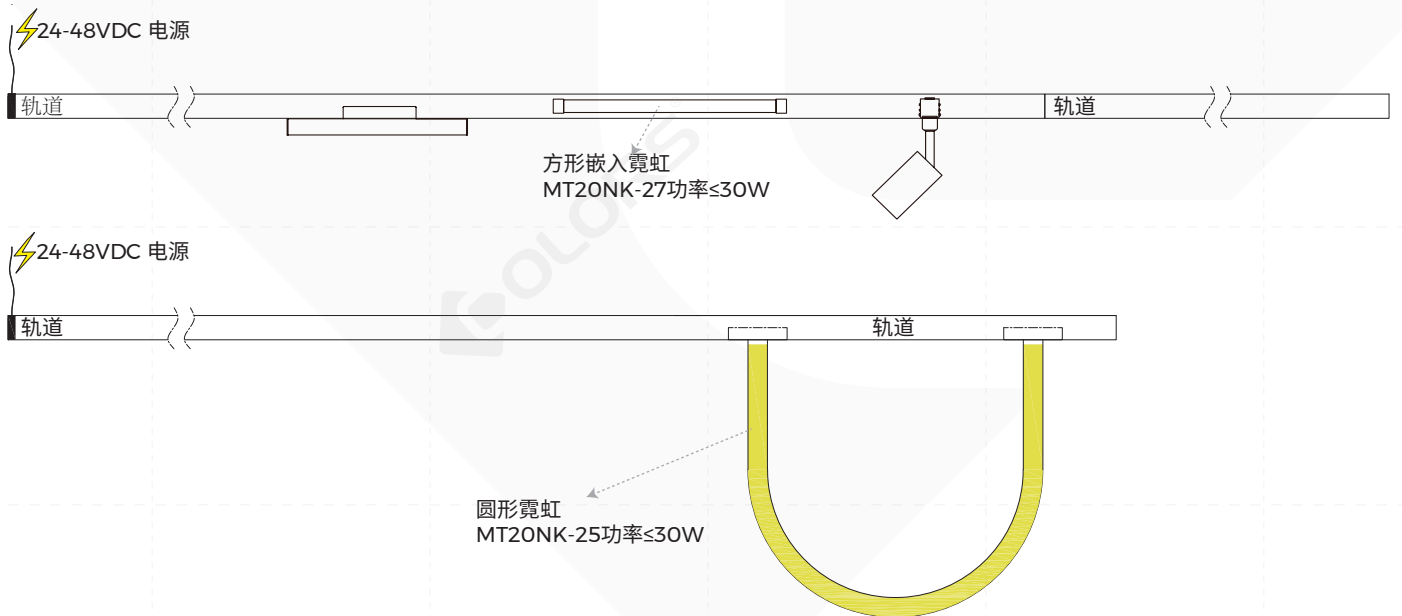

在以下任意一种情况下, 轨道条/射灯模组/线性模组/装饰模组的端头需要增加电源:

1. 方形霓虹 MT20NK-27功率 $>$ 30W;
2. 圆形霓虹 MT20NK-25功率 $>$ 30W;
3. 如果轨道用24-48VDC作为电源, 那么只能选择输入电压支持24-48VDC的灯具模组
4. 如果轨道用48VDC作为电源, 那么可选择输入电压支持24-48VDC或者仅支持48VDC的灯具模组

◎MagTrack 20 配件信息

图片	名称	商城型号
	无边嵌入轨道 (9.5mm石膏板)	TLS-MR2X0(A)
	无边嵌入轨道 (12.5mm石膏板)	TLS-MR2X0(B)
	无边嵌入轨道 (常规批灰)	TLS-MR2X0(C)
	吊装/吸顶轨道	TLS-MS2X0
	吊装/吸顶轨道	TLS-MH2X0
	φ 800mm 90° 无边嵌入弧形轨道 (9.5mm石膏板)	TLS-MR208A90(A)
	φ 1000mm 90° 无边嵌入弧形轨道 (9.5mm石膏板)	TLS-MR210A90(A)
	φ 1200mm 90° 无边嵌入弧形轨道 (9.5mm石膏板)	TLS-MR212A90(A)
	φ 800mm 90° 无边嵌入弧形轨道 (12.5mm石膏板)	TLS-MR208A90(B)
	φ 1000mm 90° 无边嵌入弧形轨道 (12.5mm石膏板)	TLS-MR210A90(B)
	φ 1200mm 90° 无边嵌入弧形轨道 (12.5mm石膏板)	TLS-MR212A90(B)
	φ 800mm 90° 吊装/吸顶弧形轨道	TLS-MH208A90
	φ 1000mm 90° 吊装/吸顶弧形轨道	TLS-MH210A90
	φ 1200mm 90° 吊装/吸顶弧形轨道	TLS-MH212A90

图片	名称	商城型号
	轨道取电器	TLS-M261
	取电器	TLS-M264
	I型取电器 (嵌入款)	TLS-M265
	I型取电器 (明装款)	TLS-M266
	堵头	EC-MR20
	堵头	EC-MS20
	堵头	EC-MH20
	轨道遮光面罩	CV-M20FB
	吸顶配件	TLS-M271
	吊绳套装	TLS-M272
	吸顶螺丝	CL-01

图片	名称	商城型号
	L型转角 (侧弯)	L90-MR20(A)
	L型转角 (内弯)	L90N-MR20(A)
	L型转角 (侧弯)	L90-MR20(B)
	L型转角 (内弯)	L90N-MR20(B)
	L型转角 (侧弯)	L90-MR20(C)
	L型转角 (内弯)	L90N-MR20(C)
	L型转角 (侧弯)	L90-MS20
	L型转角 (内弯)	L90N-MS20
	L型转角 (侧弯)	L90-MH20
	L型转角 (内弯)	L90N-MH20
	L型可调转角 (侧弯)	L90-MH20(A)
	T型可调转角 (侧弯)	T90-MH20(A)
	X型转角 (侧弯)	X90-MH20(A)

图片	名称	商城型号
----	----	------



CASAMBI控制器

T200EN1812-CAS-XX-BLDAV48



磁吸电源
(48V/100W)

MT20-HDRV100H48S-M



磁吸电源
(48V/200W)

MT20-HDRV200H48S-M



48V恒压电源

BN-V48-XXXP

备注:

- 1、详细参数请参考配件使用手册
- 2、配件不共用, 轨道需搭配对应的配件使用。

◎MagTrack 20产品系列经济款配件

图片	名称	商城型号
	无边嵌入轨道 (常规批灰款)	TLS-ECO-MR2X0
	无边嵌入轨道 (12.5mm石膏板)	TLS-ECO-MR2X0(A)
	吊装/吸顶轨道	TLS-ECO-MS2X0
	吊装/吸顶轨道	TLS-ECO-MH2X0
	堵头	EC-ECO-MS20
	堵头	EC-ECO-MH20
	L型转角 (侧弯)	L90-ECO-MS20
	L型转角 (侧弯)	L90-ECO-MH20
	吊绳套装	TLS-ECO-M280
	I型取电器 (明装款)	TLS-ECO-M281

备注:

- 1、详细参数请参考配件使用手册
- 2、配件不共用, 轨道需搭配对应的配件使用。

◎ NeonTrack产品应用

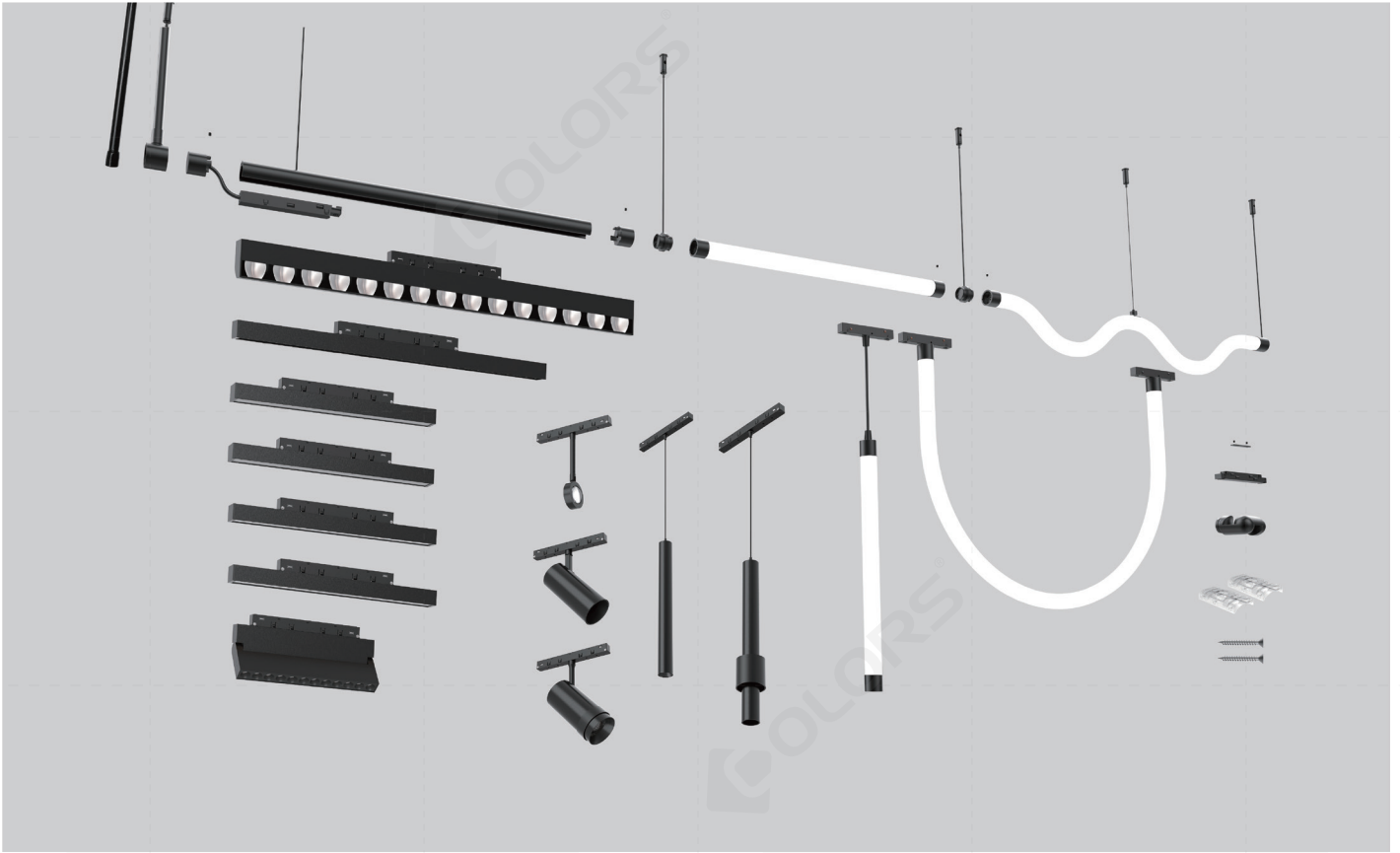

◎ 电源使用注意事项

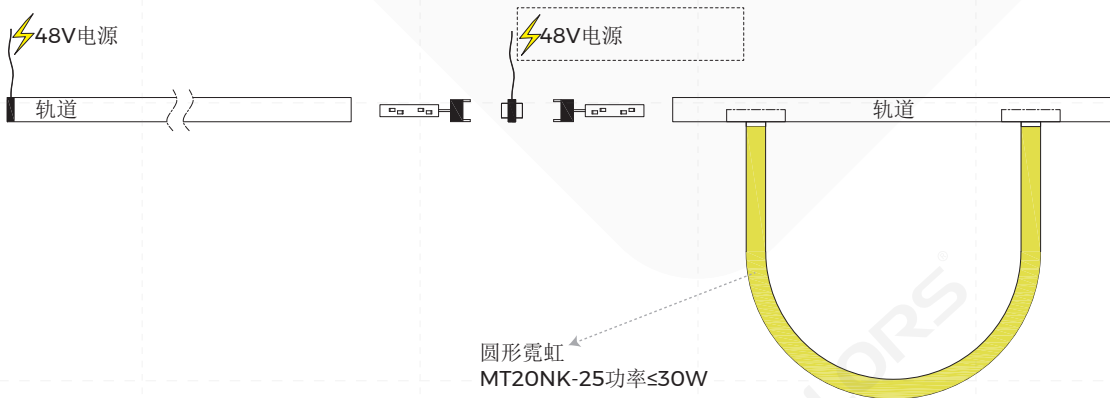
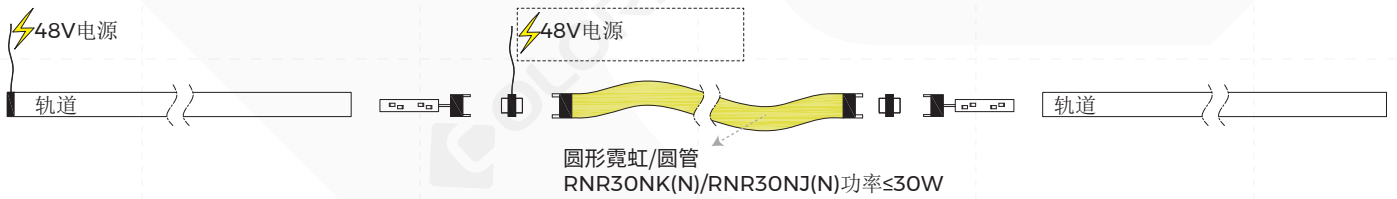
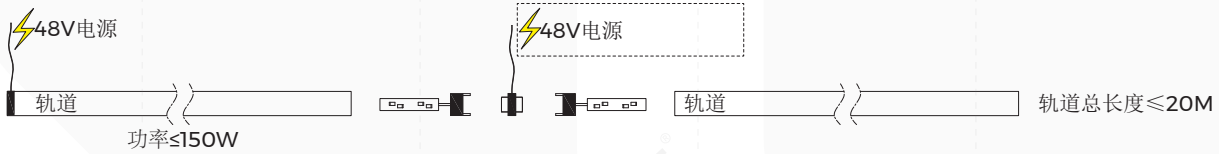

在以下任意一种情况下, 轨道条/射灯模组/线性模组/装饰模组的端头需要增加电源:

1. 轨道总功率 > 150W或者轨道总长度>20米;
2. 圆形霓虹/圆管功率 > 30W;

◎NeonTrack 配件信息

图片	名称	商城型号
	圆形轨道	TLS-R6X0
	堵头	TLS-R600
	转动连接器	TLS-R860
	直连接器	TLS-R861
	轨道取电器	TLS-R862 (N)
	I型取电器	TLS-R863 (N)
	轨道母头	TLS-R865
	吸顶螺丝	CL-Z1
	轨道吊杆套装	PG-I
	轨道吊绳套装	PN-D

图片	名称	商城型号
	吸顶配件套装 (霓虹软管)	CL-18
	吊绳套装 (霓虹灯)	TLS-R892
	吊杆套装(霓虹灯) (1-2米长度可调)	TLS-R893
	吊杆套装(霓虹灯) (0.5-1米长度可调)	TLS-R895
	48V恒压电源	BN-V48-XXXP

备注:

- 1、详细参数请参考配件使用手册
- 2、配件不共用, 轨道需搭配对应的配件使用。

◎包装信息

产品型号	内盒尺寸 (mm/盒)	产品数量 /盒	产品数量 /箱	净重 (kg/盒)	净重 (kg/箱)	毛重 (kg)	尺寸 (mm/箱)
TLS-MT20G0110-06904030-NBB	310*48*30	1	30	0.12	3.6	4.5	630*154*160
TLS-MT20G0220-12904030-NBB	310*48*30	1	30	0.17	5.1	6	630*154*160
TLS-MT20G0440-24904030-NBB	610*48*30	1	15	0.27	4.05	5.1	630*154*160

◎产品型号

TLS	-	M	T	20	G	0110	-	06	90	40	30	-	N	B	B
系统 TLS 轨道照明系统		系列 M: 磁吸模组	安装方式 T: 轨道	轨道尺寸 20: 20mm	面罩类型 G: 格栅罩	产品长度 0110: 110mm 0220: 220mm 0440: 440mm		典型功率 06: 6W 12: 12W 24: 24W	显指 90: Ra>90	成品色温 27: 2700K 30: 3000K 40: 4000K	光束角 30: 30° 55: 55°		调光方式 N: 非调光 D: 10V调光 A: DALI调光 X: 无调光	产品颜色 B: 黑色 W: 白色	面罩颜色 B: 黑色

◎注意事项

- 非专业人员, 禁止对产品进行安装、拆卸和维修; 灯具用于照明, 并根据电力法律法规和安装说明进行安装/拆除;
- 在安装过程中请避免对产品进行刮花、扭曲以及不规则的弯曲, 否则有可能给产品造成无法修复的损伤;
- 裁剪时请使用专业裁剪工具;
- 严禁使用任何酸性、碱性粘接剂固定产品;
- 产品仅适用于室内干燥场所, 请勿应用在户外, 海边, 潮湿浸水等环境。